

Wardrobe Rails and Supports

Oval

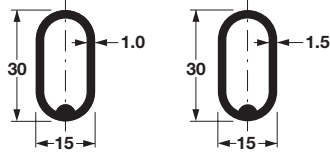
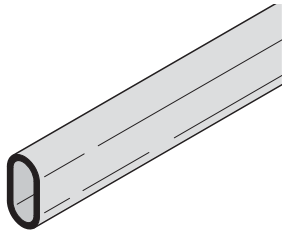

Welded tube

Oval Wardrobe Rail, welded
 Dimensions:
 30 x 15 x 2500 (98 7/16") Length
 Material: steel or PVC



Finish/Color	Material thickness	Item No.
chrome-plated	1.0	801.13.201
brass-plated	1.0	801.06.805
white PVC	1.0	801.13.702
chrome-plated	1.5	801.09.226

Packing: 10 pcs.

Oval Wardrobe Rail

Dimensions: 30 x 15 x 2438 (96") Length
 Thickness: 1.3
 Material: aluminum

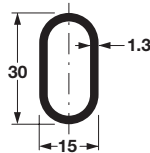

Finish	Item No.
matt aluminum	801.13.391
matt nickel	801.13.691
dark oil-rubbed bronze	801.13.191

Packing: 12 pcs.

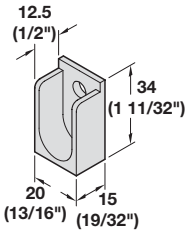
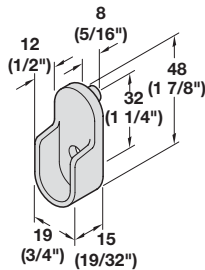

Wardrobe Rail Support

- For insertion in 32 mm system holes, with attached dowels and an additional screw hole

Material: zinc die-cast

Finish/Color	Item No.
nickel-plated	803.33.722
chrome	803.33.210
brass-plated	803.33.520
white	803.33.830
matt aluminum	803.39.300
matt nickel	803.39.600
dark oil-rubbed bronze	803.39.100

*Packing: 200 pcs.

Wardrobe Rail Support

- For screw-mounting on side panel

Material: plastic

Finish/Color	Item No.	Packing
chrome-plated	803.25.220	*200 pcs.
black	803.25.328	10 pcs.

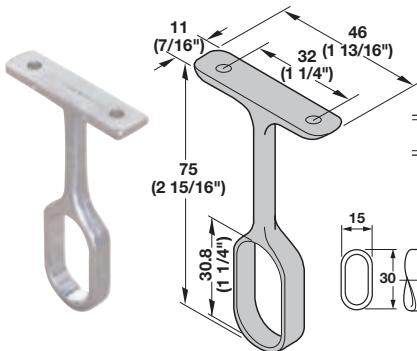

Oval Center Bracket, surface mount

- For 15 x 30 mm rail
- Material: zinc die-cast

Finish	Item No.
chrome-plated	802.04.208

*Packing: 100 pcs.

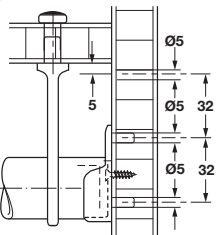

Oval Center Bracket, top mount

- For 15 x 30 mm rail, mounts with M6 screw
- Material: zinc die-cast

Finish	Item No.
chrome-plated	802.03.201

*Packing: 100 pcs. (includes mounting screw)

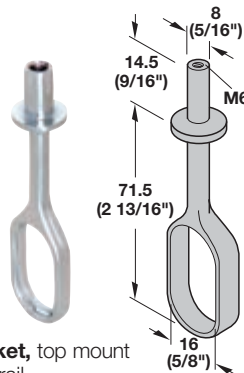

End Caps, for oval wardrobe rail

- For oval tubes that are 30 x 15 x 1.0 in size
- Caps are inserted in by pushing into the end of the tube

Material: plastic

Finish/Color	Item No.
chrome-plated	802.05.295
white	802.05.795

*Packing: 500 pcs.